

Size



Size (Design: Jehs + Laub)

Minimalismus als Prinzip. Das Merkmal dieser Produktfamilie ist seine formale Ruhe und Klarheit. Schlanke Wangen aus Aluminium oder Korpusse in unterschiedlichen Dimensionen tragen eine 60 mm starke Tischplatte. Meisterhafte Verarbeitung und edle Materialien wie ausgewählte Hölzer und Metallic-Lacke eröffnen gestalterischen Freiraum.

Size (Design: Jehs + Laub)

Minimalism as principle. Clarity and tranquility of form. Individualistic unobtrusiveness. The 60-mm tabletop floats lightly atop the sleek lateral panels or base units of various sizes. Masterful craftsmanship and premium materials such as selected woods and metallic lacquers open up a world of freedom to create personal nuances.







Size | Vereinigte Volksbank e.G, Böblingen



Size

Details

Wange aus Aluminium 1,2 cm stark, Container 50 cm breit.

Side panel made of aluminum 1,2 cm thick, container 50 cm wide.



Der horizontale Kabelkanal aus Aluminium ist aufklappbar und wird an der Mittelzarge befestigt. Die in der Oberfläche der Wange lackierte vertikale Kabelführung wird an der Innenseite der Wange befestigt.

The horizontal aluminium cable channel swings open and is attached to the centre crossbar. The lacquered vertical cable conductor is attached to the inside surface of the side panel.

Lederschiebepatte mit Ablagefächern und Elektroleiste.

Sliding leather desk pad with compartments and power strip.

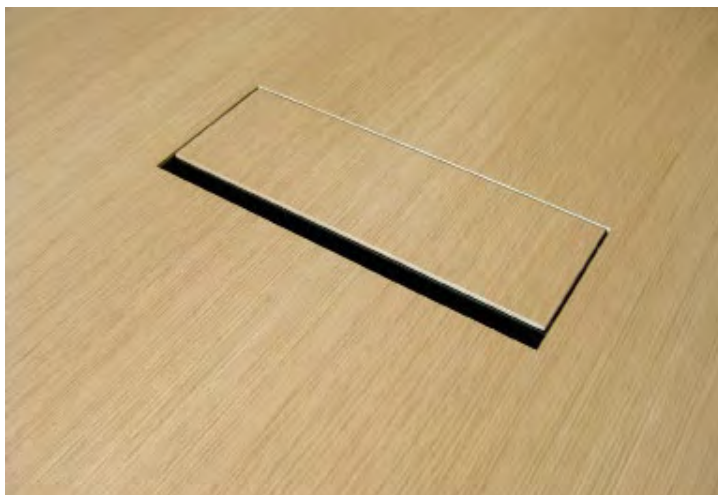

Die ein- oder doppelseitige Elektrobox ist flächenbündig in die Tischplatte integriert. Der Klappdeckel wird in der Ausführung der Tischplatte gefertigt.

The single or double-sided power box is leveled into the table top and finished to match the table top.



Size

Maße/Dimensions

Schreibtisch mit 2 Wangen. Desk with 2 side panels.

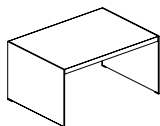

142,4 x 100
Höhe height 73/75

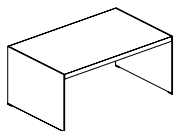

162,4 x 100
Höhe height 73/75

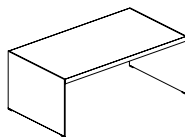

182,4 x 100
Höhe height 73/75

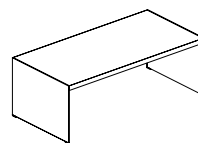

202,4 x 100
Höhe height 73/75

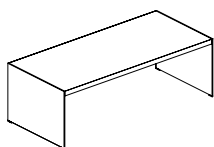

222,4 x 100
Höhe height 73/75

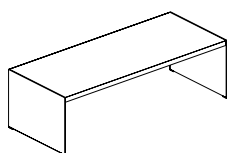

242,4 x 100
Höhe height 73/75

Schreibtisch mit angebautem Container. Desk with end container.

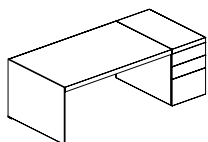

211,2 x 100
Höhe height 73/75

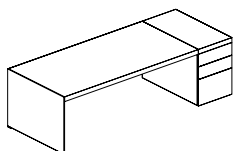

251,2 x 100
Höhe height 73/75

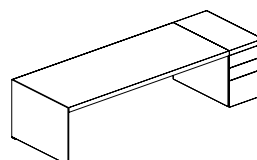

291,2 x 100
Höhe height 73/75

Winkeltisch. Return table.

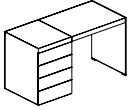

131,2 x 60
Höhe height 73/75

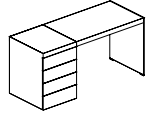

151,2 x 60
Höhe height 73/75

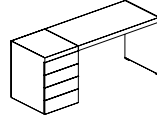

171,2 x 60
Höhe height 73/75

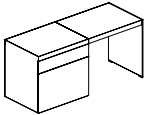

156,2 x 60
Höhe height 73/75

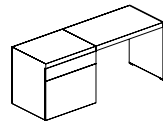

176,2 x 60
Höhe height 73/75

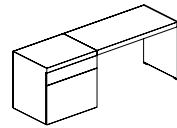

196,2 x 60
Höhe height 73/75

Roll-Container. Mobile container.



50 x 60
Höhe height 57

Size

Maße/Dimensions

Highboard. Highboard.

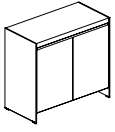

110,4 x 55
Höhe height 101

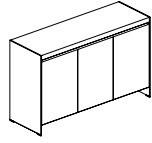

163,4 x 55
Höhe height 101

Sideboard. Sideboard.

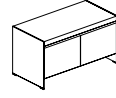

110,4 x 55
Höhe height 60

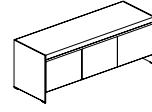

163,4 x 55
Höhe height 60

Wandpaneel. Wall panel.

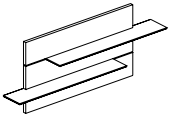

160 x 32 x 90

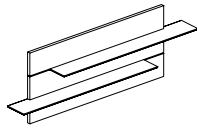

200 x 32 x 90

Besprechungstisch. Meeting table.

für 4 Personen
for 4 people



Ø 110
Höhe height 73

für 6 Personen
for 6 people

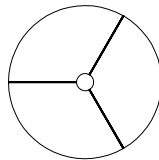

Ø 180
Höhe height 73

für 8 Personen
for 8 people

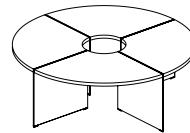

Ø 210
Höhe height 73

für 8 Personen
for 8 people

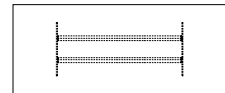

240 x 100
Höhe height 73

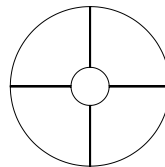
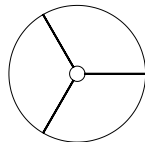

Beispielhafte Schreibtischkonfiguration. Exemplary desk configuration.

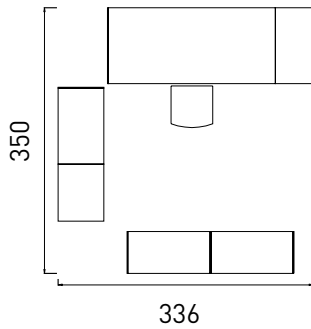

Schreibtischkonfiguration bestehend aus:

Tischplatte 209	220 x 100
Container 244 Re	50 x 100
Winkeltischplatte 220	100 x 60
Technik-Container 264 Li	75 x 60
2 x Sidboardelemente 292 à	108 x 55

Desktop configuration consisting of:

Top 209	220 x 100
Container 244 RH	50 x 100
Return top 220	100 x 60
CPU-Container 264 LH	75 x 60
2 x Credenza 292 à	108 x 55

Beispielhafte Konferenztischkonfigurationen. Exemplary conference table configurations.

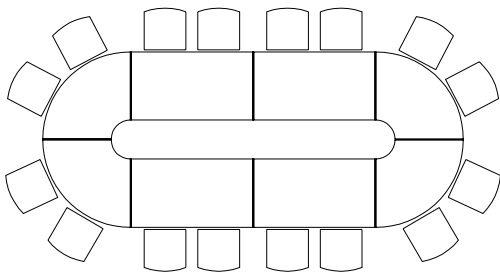

554 x 231
Höhe height 73

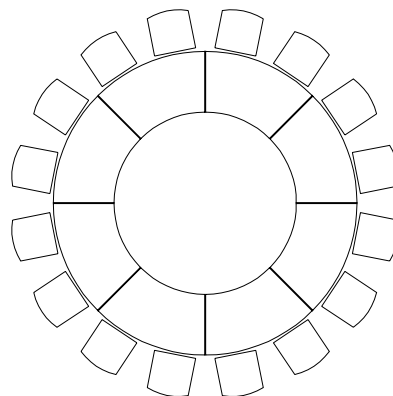

Ø 400
Höhe height 73

Size

Besprechungstische/Meeting tables

Alle Size Besprechungstische haben 40 mm starke Tischplatten, die grundsätzlich querfurniert sind. Der Furnierverlauf an der Kante ist senkrecht. Der Unterschied zeigt sich bei den Gestellvarianten: Der runde Besprechungstisch für 4 Personen hat einen Mittelfuß, bei den größeren Tischen für 6 und 8 Personen werden die Platten zwischen Aluminiumwangen eingespannt. Beim rechteckigen Tisch sind die Wangen unter dem Tisch eingerückt.

All Size conference tables feature standard 40-mm cross veneer tabletops. The edge veneer runs vertically. Bases vary according to model. The round conference table for four people features a centre leg. The larger tabletops of the six-person and eight-person tables are fixed between aluminium side panels. The rectangular table has recessed side panels.



270 | Ø 110 cm

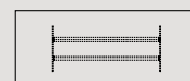

271 | 240 x 100 cm

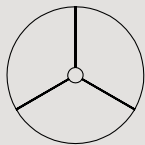

272 | Ø 180 cm

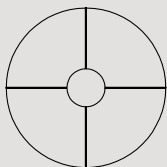

273 | Ø 210 cm

Size

Individuelle Lösungen/Individual solutions

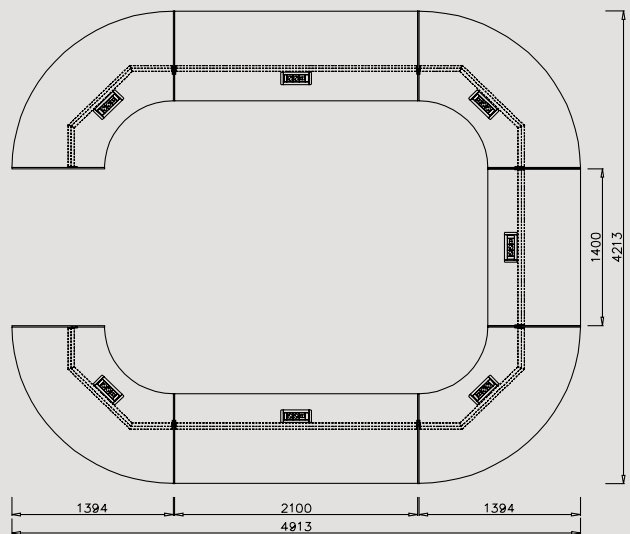
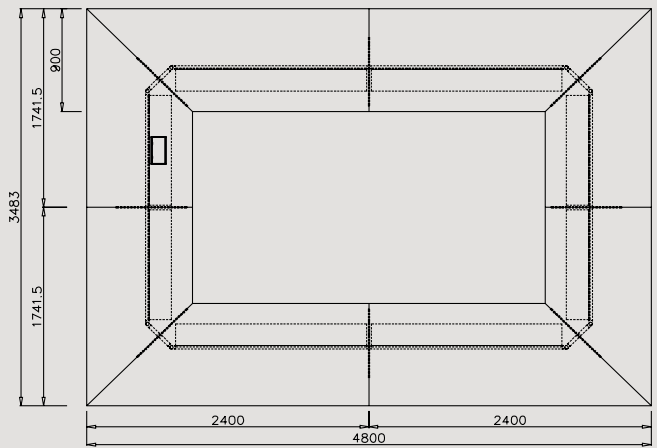
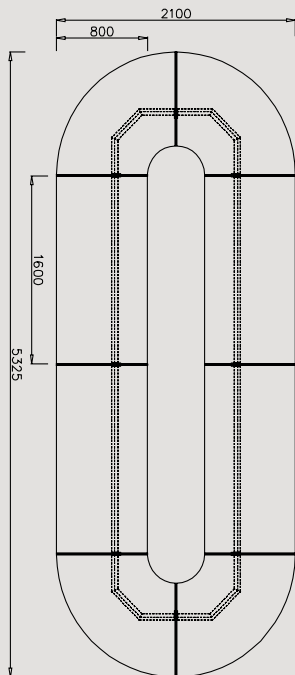
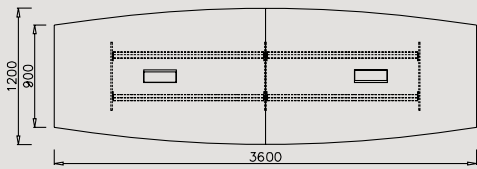

RENZ plant und fertigt Tische und Tischanlagen nach Ihren Vorgaben und Vorstellungen. Exklusive Sonderlösungen, individuell angepasst, in von der Serie abweichenden Maßen, Formen und Materialien. Sprechen Sie mit unseren erfahrenen und kompetenten Spezialisten oder mit den Fachleuten unserer ausgewählten Handelspartner.

RENZ designs and manufactures tables and table systems according to your wishes and specifications. Exclusive custom solutions to accommodate your unique needs can incorporate non-standard sizes, forms and materials. Talk to our competent, experienced specialists or to the experts at our selected partner firms.



Size

Materialien /Materials

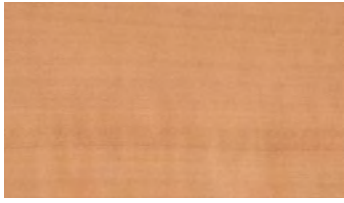

Birnbbaum natur
Pear natural



Am. Kirschbaum natur
Am. Cherry natural



Eiche matt
Oak matt



Eiche hell
Oak light



Eiche titangrau
Oak grey titan



Eiche urban grey
Oak urban grey



Räuchereiche
Oak smoked

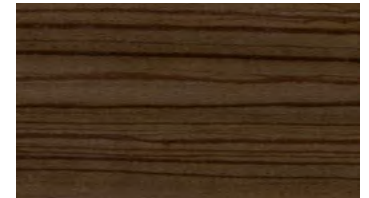

Zebrano grau
Zebrano grey



Zebrano natur
Zebrano natural



Am. Nussbaum natur
Am. Walnut natural



Nussbaum tabac
Walnut tobacco



Eiche schwarz
Oak black

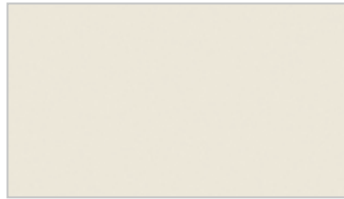

Lack Hochglanz weiß
Lacquer high gloss/silk matt white



Lack alusilber
Lacquer aluminium silver



Lack alugrau
Lacquer aluminium grey

Die abgebildeten Farben sind nicht farbverbindlich. Die Darstellung kann je nach Monitor und Drucker variieren. Weitere Oberflächen Ausführungen wie Furniere, Laminat und Linoleum nach Muster auf Anfrage.

The colours shown are intended as a guideline only. Their representation may vary depending on the monitor and printer. Further surface finishes such as natural wood veneer, laminate and linoleum on request by sample.

Wilhelm Renz GmbH + Co. KG
Hanns-Klemm-Straße 35
71034 Böblingen
Germany

T +49 (0)7031.21880
F +49 (0)7031.218850

info@renz.de
www.renz.de

